

# VIKING

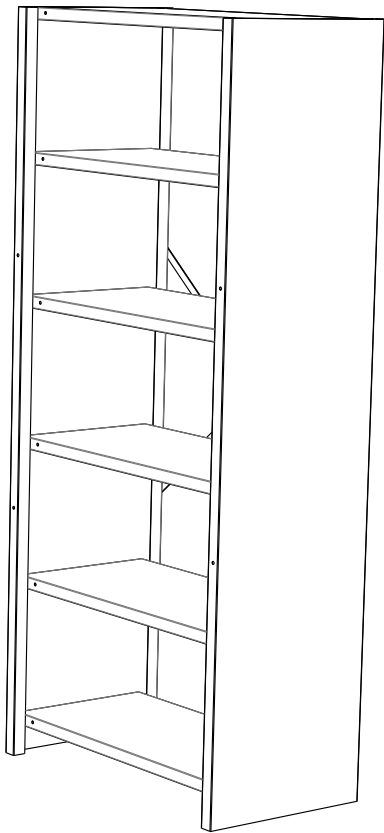

**2x**

СТУ-XX.02.00

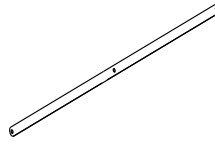

**2x**



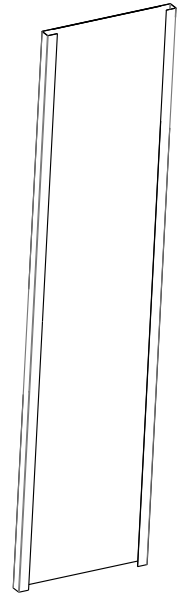



СТУ-XX.00.01

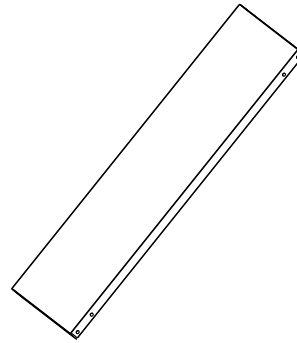

**6x**

ПЛ-XX.00.00



<b>29x</b> 1.2.7985.6x16 	<b>29x</b> 1.5.934.6 	<b>29x</b> 1.4.125.6 	<b>1x</b> 1.2.7985.5x16  IF ESD	<b>1x</b> 1.5.934.5  IF ESD	<b>1x</b> 1.4.9021.5  IF ESD	<b>1x</b> 2.5.1  L=1000mm IF ESD
---	--	--	---	---	--	---

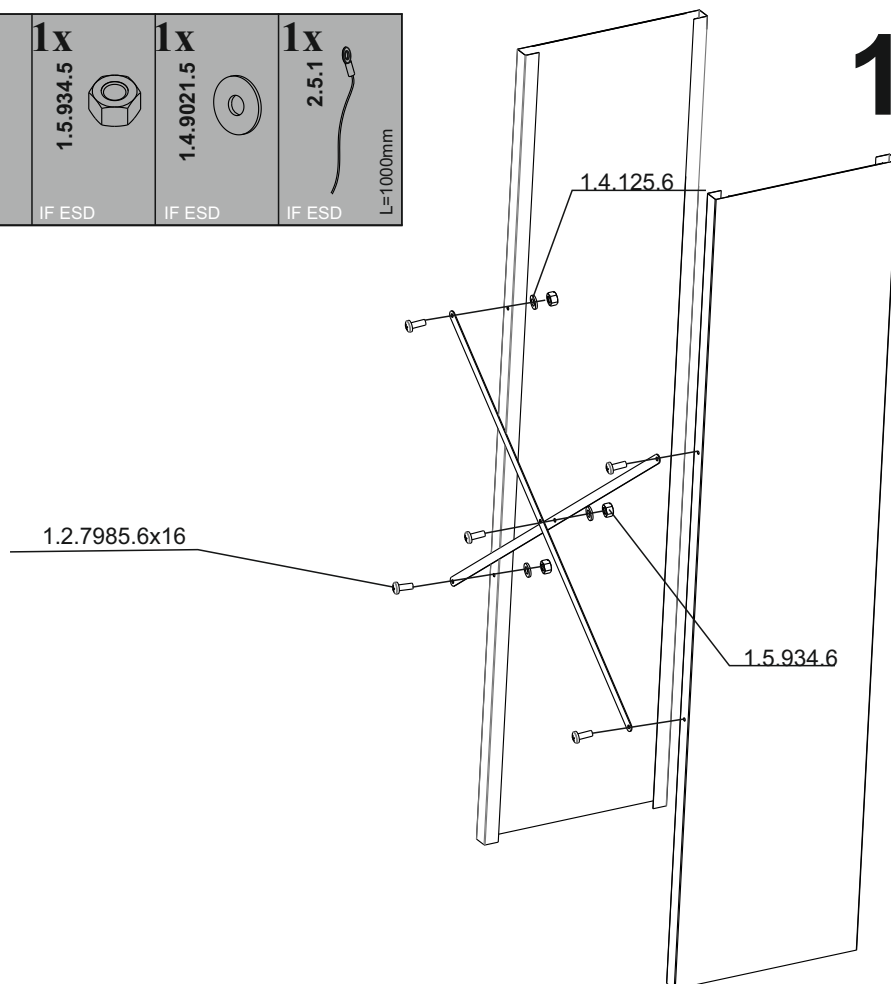

# 2 x6

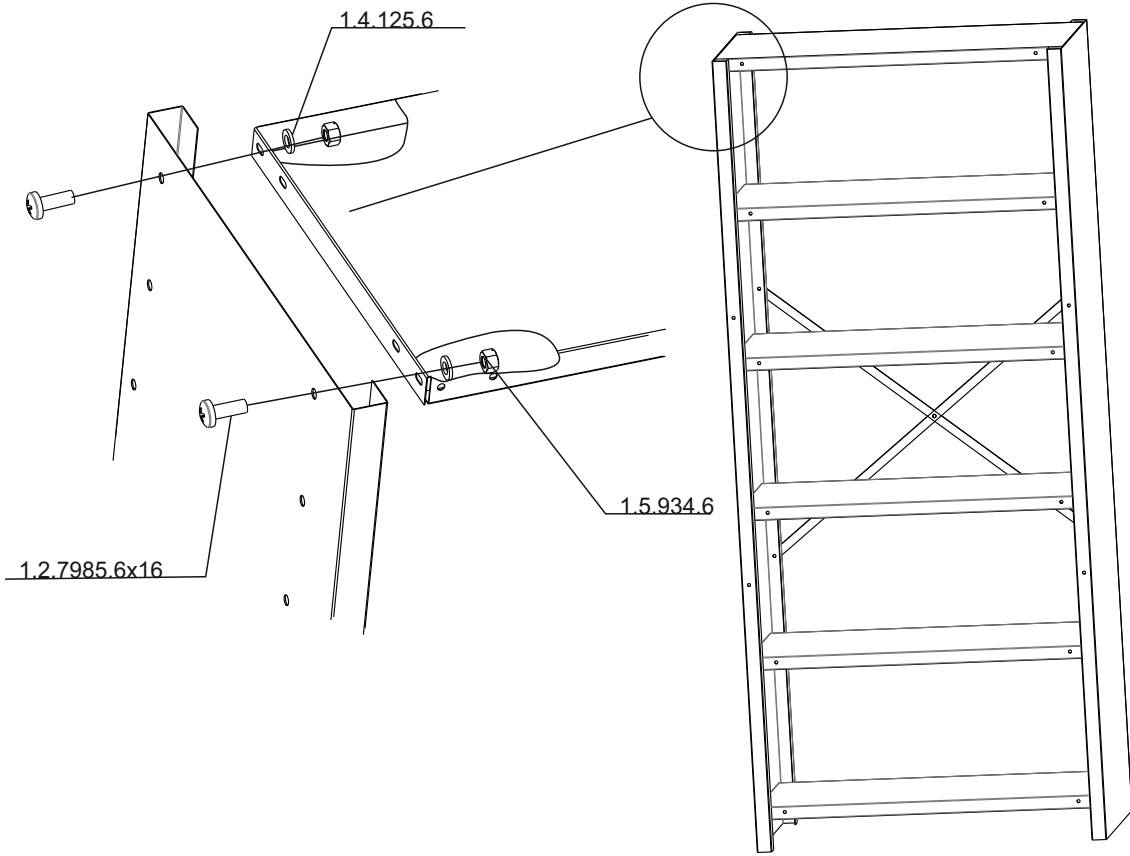

# 3

